



**DEiTECH** | **IMPULSE** TECHNOLOGY | **THERMAL MASS** TECHNOLOGY

Refrigeration dryers with Energy Saving Impulse Technology and Thermal Mass  
Nominal air flow 0,3 - 32 m<sup>3</sup>/min.



*Purifying your compressed air,  
increasing your efficiency.*



Cooling, conditioning, purifying.



# DEiTECH | IMPULSE TECHNOLOGY | THERMAL MASS TECHNOLOGY

## Refrigeration dryers with Energy Saving Impulse Technology and Thermal Mass

With the introduction of DE iTECH, the new generation of energy-saving refrigeration dryers, MTA not only renews its product offering for the compressed air treatment but also reinterprets the concept of **thermal storage** operation, that made the international success of the DE Hybrid dryers. The new **Impulse Technology** offers important advantages in terms of energy saving, reliability and operating costs as the DE iTECH dryer is able to adapt itself to the real needs of the compressed air system. The regulation system of the dryer controls the dryer operation granting the most energetically effective method of compressed air drying, achieving high energy saving and ensuring at the same time an excellent dew point stability also in dynamic conditions.



### Enhanced Energy Savings

New 3-in-1 high efficiency heat exchanger with optimized fluid dynamics useful to keep the pressure drops to a minimum level. Advanced drying capacity control by impulses or by thermal storage effect. Enhanced energy savings (up to 80% compared with hot gas by-pass dryers).

### Reliable Drying & Separation

The stainless steel demister separator efficiently removes the condensed moisture at all airflows (unlike centrifugal separators). This ensures a high grade of drying all the time.

### High Operating Limits

High maximum inlet temperature +70°C (DEiT 003-101) +65°C (DEiT 121-320) and maximum ambient temperature [+46°/50°C] ensure a fail-safe operation at all times. High maximum operating pressure (16 barg).

### Easy installation

Advanced design makes this dryer extremely compact and lightweight. Small footprint and frontal access for all controls and refrigeration components save valuable plant floor space.

### User Friendly

DE iTECH automatically adapts itself to any operating condition, without any need to adjust or switch OFF the dryer. User friendly digital control is standard on all the models and shows all the main parameters, providing warnings and alarms to ensure correct dryer operation.

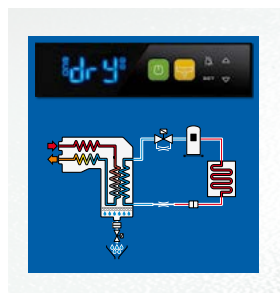



**UNBEATABLE ENERGY EFFICIENCY, LOW PRESSURE DROPS, MAXIMUM RELIABILITY, SYSTEM SIMPLIFICATION: THESE ARE THE ADVANTAGES OF MTA DRYERS.**



Cooling, conditioning, purifying.

## IMPULSE TECHNOLOGY ENERGY SAVING

This revolutionary design matches energy consumption to the work load to achieve energy savings while in operation.

Thanks to some sensors placed on the refrigeration and on the compressed air circuits, the microprocessor controls the dryer operation granting the most effective method of compressed air drying.



- For high/medium flows, the dryer applies the **Impulse Technology** to regulate its drying capacity.
- For low air flows, the dryer utilizes the **“thermal storage”** operation.

### IMPULSE TECHNOLOGY FOR HIGH/MEDIUM AIR FLOWS

The refrigerant compressor is permanently ON to achieve a perfect control of the dew point. The microprocessor controls through “impulses” the opening and closing of a solenoid valve installed on the suction pipe of the refrigeration compressor, in partial load conditions then only a small portion of the nominal refrigerant flows through a by-pass calibrated orifice of the solenoid valve to the compressor.

In partial load conditions the compressor compresses less refrigerant than at peak load and therefore it consumes less energy (refrigerant flow control technology).

### THERMAL STORAGE OPERATION FOR LOW AIR FLOWS

The refrigerant compressor cycles ON/OFF for maximum savings and reliability. Since the refrigeration capacity is greater than the load, the excess capacity cools the all-in-one exchanger that acts like a thermal storage.



#### Reliable operation

The simple refrigeration circuit, without hot gas by-pass valve, and the careful selection of the materials and components assure long, trouble free service life. The condenser coil is generously sized to maintain efficiency in all environments even at high ambient temperatures.

#### Easy Serviceability

Removable frontal panel assures easy access to the main refrigeration components, thus facilitating maintenance operations also with dryer ON. There is no need of seasonal adjustments unlike hot gas by-pass dryers. Condenser filters standard (DEiF 101-320) prevent mechanical equipment fouling by stopping debris.

#### Guaranteed Quality

All models are individually tested: refrigerant charge and leakage control, microprocessor and safety device setting verification. Leading brand components are used throughout, ensuring long term reliability.

#### Respect of Environment

DE iTECH's energy savings coupled with R134a and R410A non ozone depleting refrigerants, reduce the environment impact minimizing the energy waste. Recyclable and high quality materials ensure respect of environment. and reduced carbon footprint.

#### Robust Design

Heavy duty structure with panels protected by an epoxy polyester powder coating. Electrical panel (DEiF 140-320) is IP54 compliant with EN 60204-1 and tested for electromagnetic compatibility in accordance with applicable EMC standards. Phase monitor standard DEiF 165-320.

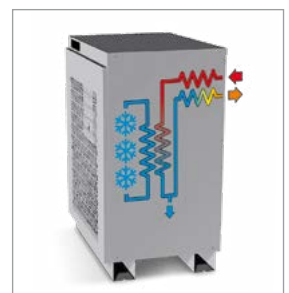
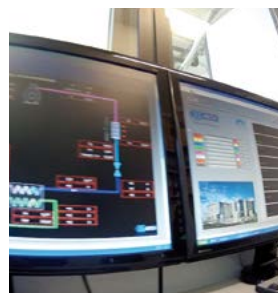

## Built to perform

### NO NEED OF SEASONAL SETTING

Even with variable working conditions or ambient temperature the Impulse Technology let the DEiTECH to control accurately dew points without the need of any setting (HGBV requires recurring adjustment as it is a mechanical device).

### Innovative design

### ADVANCED DIGITAL CONTROL

DE iTECH features advanced microprocessor control technology, with all models fitted with easy to use digital controls. A comprehensive digital display keeps the user fully informed. Maintenance operations are simplified, and remote supervision RS485 can easily be supplied.



- The display shows continuously with icon-based menus the following parameters: Status of the dryer (OFF/dry/hdP); Status of the compressor; Status of condensate drain; Energy saving level; Alarms.
- 3 coded alarms ensuring faultless dryer operation.
- Programmable user alarm.
- Service warning, informing user that preventive maintenance should be carried out.
- Condensate drain control and programming, including manual drain test function.
- Remote ON/OFF function.
- General alarm contact for remote alarm indication.
- Possibility to connect the dryer to a supervisor system via RS485 Modbus (option).

### HIGH-PERFORMANCES CONDENSER

The air-cooled condenser is designed to ensure operation up to 50°C external temperature and to achieve very high energy efficiency values. DEiT 003-032 are supplied with tubeless condenser with steel fins protected by a double layer dipping painting. DEiT 040-320 are equipped with a condenser coil with copper tubes and aluminium fins. Thanks to the ducted condenser coil, the maintenance activities are possible also with dryer ON. Condenser filters standard on DEiT 140-320.

### REFRIGERATION COMPRESSORS FULLY HERMETIC

Piston/rotary compressors (DEiT 003-140) ensure high reliability and long service life. Scroll compressors (DEiT 165-320) offer reduced energy consumptions, low vibrations, less moving parts and high reliability.

### ENVIRONMENTALLY FRIENDLY REFRIGERANTS

R134a refrigerant: DEiT 003-101  
R410A refrigerant: DEiT 121-320

### HIGH EFFICIENCY 3-IN-1 HEAT EXCHANGER

3-in-1 compact aluminium heat exchanger including an Air-Air heat exchanger, the evaporator and a separator combined in a single module.

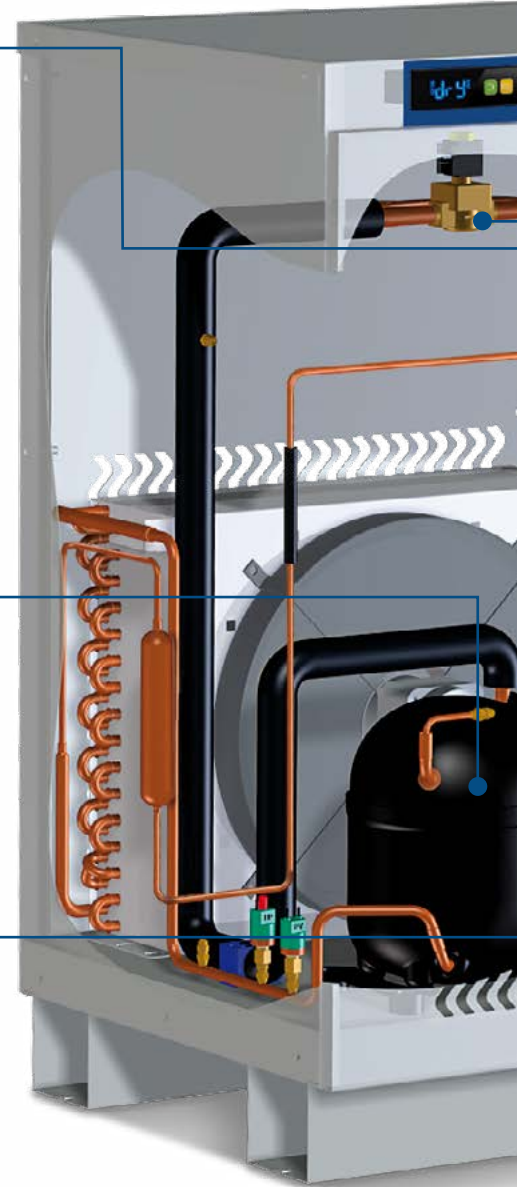

Cooling, conditioning, purifying.

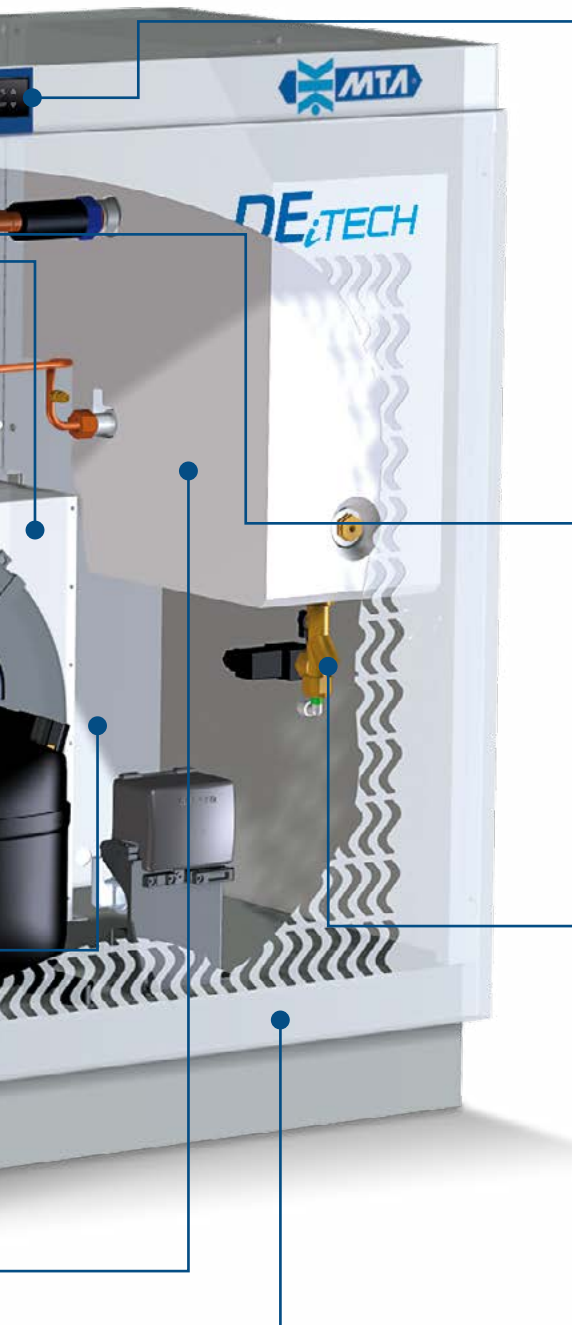

### ELECTRIC POWER AND CONTROL PANEL

The control section is electrically isolated from the power section through a transformer. On DEiT 140-320 the power section is fitted with an interlocked door main switch to prevent access while power supply is ON. Electrical equipment is compliant with EN 60204-1 and electrical panel protection degree IP54 compliant with EN 60529 (DEiT 140-320). Thanks to the dual frequency design the DEiT 101 and 165÷320 models are ready both for 50Hz and 60Hz applications. A phase monitor (DEiT 165-320) provides protection against phase loss and phase reversal.

### IMPULSE TECHNOLOGY

The microprocessor adapts the working cycle to the real working conditions by controlling through "impulses" the opening and closing of the solenoid valve.

### CONDENSATE DRAINS

All the dryers have microprocessor controlled drains. The drain open time and cycle time are fully adjustable and the settings can be locked in to avoid tampering.

Zero loss drain (option): a level sensor measures the level of the condensed moisture and automatically opens a valve to drain it off, preventing any pressure loss.

### ROBUST CABINET AND STRUCTURE

Heavy duty structure with panels protected by an epoxy polyester power coating RAL 7035.

Simple and safe handling by forklift or pallet truck.



It is mandatory to install a pre-filter (min. filtration grade P 3µm) to prevent module and drainer clogging.

### HIGH EFFICIENCY HEAT EXCHANGER

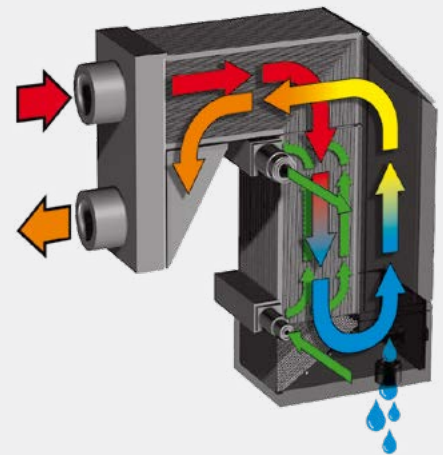

### NEW ADVANCED 3-IN-1 HEAT EXCHANGER

3-in-1 compact aluminium heat exchanger including an Air-Air heat exchanger, the evaporator and a separator combined in a single module.

The new internal geometry allowed to optimize the fluid dynamics of the heat exchanger, increasing the exchange capacity with the same surface area, keeping pressure losses to a minimum level.

### Air-to-Air Heat Exchanger

Hot and moist air enters the Air-to-Air heat exchanger where it exchanges heat in total counter flow with the outgoing cold air. Precooling saves energy by reducing the heat load on the evaporator section.

### Evaporator (Air-to-Refrigerant Heat Exchanger)

The pre-cooled air enters the evaporator where it is cooled to the required dew point by exchanging heat in counter flow with the evaporating refrigerant, allowing maximum thermal exchange. The dew point temperature is held within its optimum performance range by the microprocessor even under differing ambient conditions.

### Demister Separator

After cooling the cold air enters the high efficiency stainless steel separator where the condensate is removed by a demister falling into the generously dimensioned drainage chamber or sump for disposal through the microprocessor controlled drain.

The cold dry compressed air passes through the secondary side of the Air-to-Air heat exchanger where it is reheated by the hot inlet air it is precooling. Reheating prevents downstream pipe sweating.



# Enhanced Energy Savings

## ENERGY SAVING COMPARISON

Normally a refrigeration dryer is sized to reach its nominal performance even in the most extreme conditions. In reality, these conditions are rarely achieved and the dryer works at partial load for most of its operating life. This is due to both the high variability of the compressed air flow of industrial plants and for the average operating temperature that normally is lower than the temperature used to select the dryer itself. Only a dryer capable to adapt its working cycle to the real working conditions can provide a real energy savings.

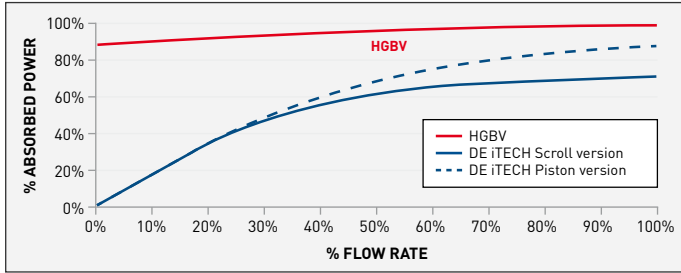

### Hot Gas by-pass Valve (HGBV)

“Non cycling” dryers work with the refrigerant compressor continuously running independently from the inlet condition, using a by-pass valve to control evaporating pressure. Energy consumption remains almost constant also in absence of compressed air flow.

### Impulse Technology (iTECH)

Impulse Technology combines the technologies of regulation by impulses of the refrigerant flow (cooling capacity control for medium/high compressed air flow) and thermal storage effect (low compressed air flow) to produce maximum energy savings and the lowest dew point.

## DEW POINT COMPARISON

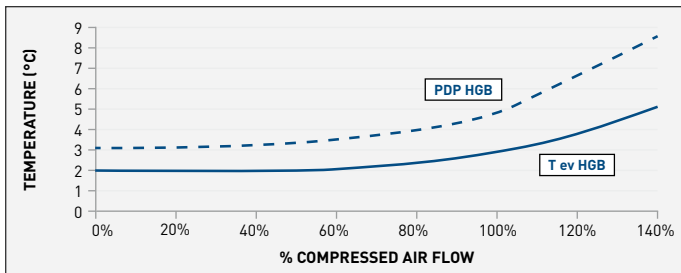

### Hot Gas by-pass Valve dryers (HGBV)

- The HGBV valve is calibrated to compensate the whole cooling capacity of the compressor in all ambient working conditions (5 °C ÷ 46°/50 °C).
- The set-up of the HGBV valve at an ambient temperature of 5 °C is completely different from the one at 50 °C .
- Normally for practical purpose the HGBV set-up is done at 25 °C ambient in order to maintain 2 °C ÷ 4 °C evaporating temperature.
- The consequence of this HGBV set-up is that the pressure dew point will never be lower than 5 °C in order to avoid icing due to the collapse of evaporation at lower ambient temperatures.

### Impulse Technology (iTECH)

- At the contrary the Impulse Technology by MTA is able to control the flow of refrigerant in order to match the thermal load with any external ambient temperature.
- The result is a perfect dew point control in every working condition ensuring nominal performance in CLASS 4.

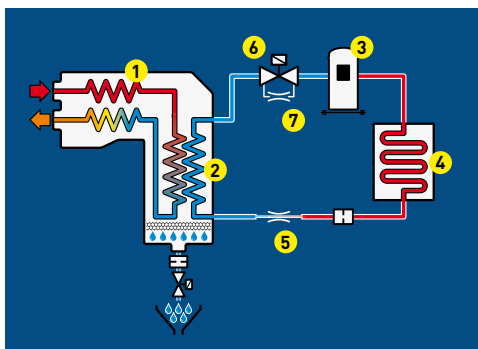

## HOW IT WORKS

Hot moist compressed air enters the Air-to-Air heat exchanger (1) where it is pre-cooled by the dry air leaving the dryer. The refrigerant compressor (3) compresses the refrigerant gas and push it through the condenser (4) where it is condensed in high pressure liquid. The refrigerant liquid then passes through a capillary/calibrated orifice (5) that meters it into the evaporator (2) as a low pressure liquid. The microprocessor adapts the working cycle to the real working conditions by controlling through “impulses” the opening and closing of the solenoid valve (6). In partial load conditions only a small portion of the refrigerant flows through the calibrated orifice of the solenoid valve (7) to the compressor that therefore consumes less energy. The pre-cooled air enters the evaporator (2) where it is cooled to the required dew point by the incoming refrigerant liquid that changes phase and becomes a low pressure gas suitable to continue the process as it returns to the suction side of the refrigerant compressor (3). The exiting cold dry compressed air then returns to the Air-to-Air heat exchanger (1) where it is reheated by the incoming air, to prevent sweating in your plant.

## ENERGY SAVING CALCULATIONS

### Productivity Savings

Compressed air networks rarely operate at full load. Air compressors typically run at 70-80% of capacity for the first shift operation, further decreasing on second and third shifts because of variable process demands as well as seasonal fluctuations in ambient temperature. DEiTECH saves energy across the full load spectrum and maximizes the bottom line energy savings.

The chart below shows a comparison between a DE iTECH 230 (23 m³/min) and a dryer which uses hot gas by-pass control. The DE iTECH 230 ensures an annual energy saving of 8103 kWh corresponding to a cost saving of 810 € and a reduction on annual CO<sub>2</sub> emissions of 2334 kg.

Compressed air flow 23 m³/min		Non Cycling Dryers	DE iTECH 230
Energy consumption per year	Kwh	24370	16266
Energy cost per year	€	2436	1626
CO <sub>2</sub> emission per year	kg	7018	4684
Energy saving per year	Kwh	-	8103
Cost saving per year	€	-	810
CO <sub>2</sub> emission saved per year	kg	-	2334

(\* ) 6000 hours/year. Load profile: for 4800 h/year, load = 80%; for 1200 h/year, load = 30%. Energy costs = 0,1 €/kWh.

### Low Pressure Drops Savings

The pressure drops generated by a refrigerant dryer must be considered as an extra load that must be overcome by the compressed air compressor to ensure the pressure level required. DE iTECH are designed and optimized from the fluid dynamics point of view to keep the pressure drops to a minimum. The graph represents the increase in power consumption (kWh per year) of a screw compressors 132 kW caused by the pressure drops (6000 working hours per year).

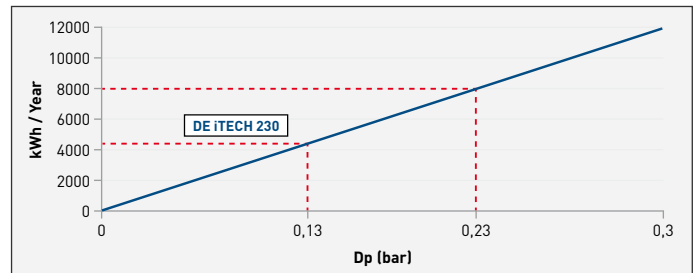

DE iTECH 230 with a pressure drop 0,13 bar provides a considerable energy saving respect another dryer with higher pressure drop 0,23 bar:  
 Annual Energy Saving = (7945 - 4490) kWh/year = 3454 kWh/year. That corresponds to an yearly cost saving of 345 € (energy cost 0,10 € per kWh) and to a reduction on annual CO<sub>2</sub> emissions of 995 kg.

DE iTECH 230 (23 m³/min)		Total savings per year
Total energy saving per year	Kwh	11557
Total cost saving per year	€	1155
CO <sub>2</sub> emission saved per year	kg	3329

Model	Nominal air flow (*)		Power supply	Nominal absorption power (*)	Air connections	Overall dimensions (mm)						Weight (Kg)			
	CLASS 4 dew point ≤ 3 °C					V/Ph/Hz	kW	Rp	A	B	C		D	E	F
	m³/min	m³/h													
DEiT 003	0,3	18	230/1/50	0,13	3/8"	319	298	390	70	32	353	18			
DEiT 005	0,5	30	230/1/50	0,17	3/8"	319	298	390	70	32	353	18			
DEiT 007	0,7	42	230/1/50	0,21	3/8"	319	298	390	70	32	353	19			
DEiT 009	0,9	54	230/1/50	0,21	1/2"	359	298	415	70	32	367	22			
DEiT 012	1,2	72	230/1/50	0,32	1/2"	359	298	415	70	32	367	22			
DEiT 018	1,8	108	230/1/50	0,38	1"	380	514	625	70	76	480	35			
DEiT 026	2,6	156	230/1/50	0,51	1"	380	514	625	70	76	480	39			
DEiT 032	3,2	192	230/1/50	0,61	1"	380	514	625	70	76	480	42			
DEiT 040	4,0	240	230/1/50	0,81	1"	680	511	860	80	79	685	68			
DEiT 050	5,0	300	230/1/50	0,85	1 1/2"	680	511	860	120	96	646	75			
DEiT 060	6,0	360	230/1/50	0,91	1 1/2"	680	511	860	120	96	646	76			
DEiT 070	7,0	420	230/1/50	1,03	1 1/2"	755	555	995	150	104	751	93			
DEiT 080	8,0	480	230/1/50	1,19	1 1/2"	755	555	995	150	104	751	94			
DEiT 101	10,0	600	230/1/50-60	1,40	2"	883	721	1107	150	123	821	138			
DEiT 121	12,0	720	230/1/50	1,09	2"	883	721	1107	150	123	821	140			
DEiT 140	14,0	840	230/1/50	1,21	2 1/2"	1170	939	1180	200	165	840	247			
DEiT 165	16,5	990	400/3/50 [460/3/60]	1,83	2 1/2"	1170	939	1180	200	165	840	254			
DEiT 190	19,0	1140	400/3/50 [460/3/60]	2,23	2 1/2"	1170	939	1180	200	165	840	255			
DEiT 230	23,0	1380	400/3/50 [460/3/60]	2,49	2 1/2"	1170	939	1180	200	165	840	252			
DEiT 270	27,0	1620	400/3/50 [460/3/60]	2,76	2 1/2"	1170	939	1180	200	165	840	276			
DEiT 320	32,0	1920	400/3/50 [460/3/60]	3,64	2 1/2"	1170	939	1180	200	165	840	285			

(\*) Data refers to the following working conditions: power supply 50 Hz, air FAD 20 °C / 1bar A, pressure 7 bar(g), ambient temperature 25 °C, air inlet temperature 35 °C, according to ISO 8573.1 standard.

Weights are net (without packing and for timed drain configuration). Refrigerant fluids: R134a (DEiT 003-101), R410A (DEiT 121-320). Protection class IP22.

Maximum working pressure 16 bar(g); maximum ambient temperature +50 °C (DEiT 003-101), +46 °C (DEiT 121-320); maximum inlet temperature +70 °C (DEiT 003-101), +65 °C (DEiT 121-320).

The correction factors in the following table should be used as a guide only; for accurate selection at conditions differing from the above the selection software should be utilised.

**Capacity Correction Factors** (indicative values): CAPACITY = RATED VALUE 7 bar(g) x K1 x K2 x K3.

working pressure	bar (g)	3	4	5	6	7	8	9	10	11	12	13	14	15	16
correction factor	K1	0,62	0,74	0,84	0,93	1,00	1,05	1,10	1,13	1,16	1,19	1,20	1,21	1,22	1,22

air inlet temperature	°C	30	35	40	45	50	55	60	65	70
correction factor	K2	1,18	1,00	0,80	0,63	0,51	0,44	0,44	0,44	0,44

ambient temperature	°C	20	25	30	35	40	45	50
correction factor	K3	1,03	1,00	0,96	0,91	0,87	0,81	0,75

DEiT 003 - 012

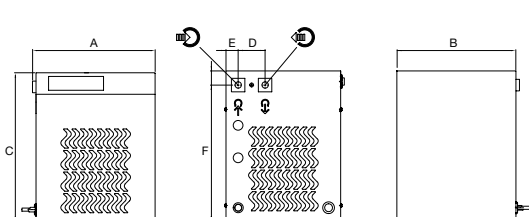

DEiT 018 - 032

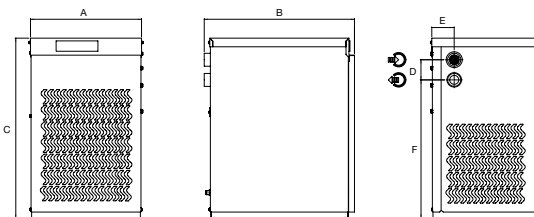

DEiT 040 - 121

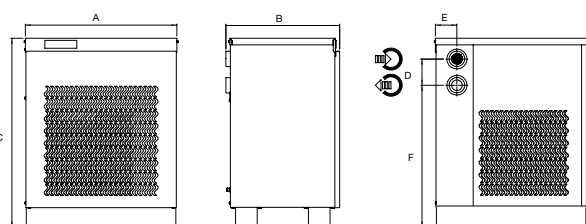

DEiT 140 - 320

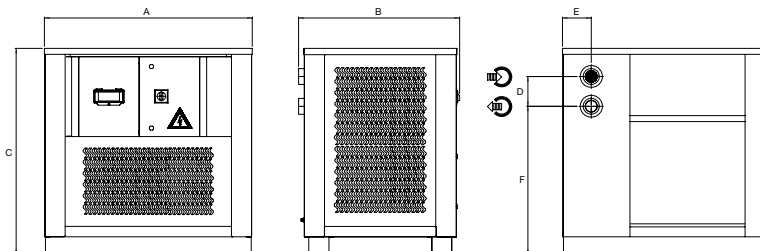

Complete your compressed air treatment system with MTA aftercoolers, separators, filters, adsorption dryers, drains, oil-water separators and chillers.





www.mta-it.com



The images of the products in the document are for illustrative purposes only and therefore do not have any contractual value.

**M.T.A. S.p.A.**  
**Business Office**  
Viale Spagna, 8 ZI  
35020 Tribano (PD) Italy

Tel. +39 049 9588611  
Fax +39 049 9588676

info@mta-it.com  
www.mta-it.com

MTA is represented in over 80 countries worldwide. For information concerning your nearest MTA representative please contact M.T.A. S.p.A.

The continuous improvement of MTA's products can cause some variations in the information herein even without prior notice. Reproduction in whole or in part is forbidden.

**MTA France S.A.**  
Tel: +33 04 7249 8989  
www.mtafrance.fr

**MTA Deutschland GmbH**  
Tel: +49 (2157) 12402 - 0  
www.mta.de

**Novair-MTA, S.A.U. (España)**  
Tel: +34 938 281 790  
www.novair-mta.com

**MTA USA, LLC**  
Tel: +1 716 693 8651  
www.mta-usa.com

**MTA Australasia Pty Ltd**  
Tel: +61 1300 304 177  
www.mta-au.com



MTA is ISO9001 certified, a sign of its commitment to complete customer satisfaction.



MTA products comply with European safety directives, as recognised by the CE symbol.



EAC Declaration



Cooling, conditioning, purifying.