











- Riavvolgimento automatico a molla
- Struttura in materiale plastico antiurto
- Staffa di fissaggio orientabile a parete in acciaio verniciato
- Sistema di bloccaggio del cavo alla lunghezza desiderata, facilmente eliminabile ed ispezionabile da parte dell'utente
- Disponibili con diverse tipologie di cavo (H05RN-F, H05VV-F, H07RN-F)
- Conformi alle norme CE
- Automatic spring rewinding
- Plastic outer casing
- Steel swivelling wall bracket
- Ratched stop device easilly inspectable and removable by the end user
- Available with different type of cable (H05RN-F, H05VV-F, H07RN-F)
- CE approved
- Kabel-Aufrollautomatik mit Federeantrieb
- Gestell aus schlagfestem Kunststoff
- Schwenkbare Wandhalterung aus lackiertem Stahl
- Sonder-Kabel-Arretierungsvorrichtung, einfach abschaltbar und kontrollierbar
- Mit verschiedenen Kabeltypen (H05RN-F, H05VV-F, H07RN-F) lieferbar
- Konform nach CE-Normen
- Enroulement automatique à ressort
- Coques en plastique antichoc
- Etrier de fixation murale en acier peint
- Système de blocage du câble à la longueur désirée, facilement éliminable et inspectable de la part de l'utilisateur
- Disponibles avec plusieurs typologies de câble (H05RN-F, H05VV-F, H07RN-F)
- Conformes aux normes CE

	Sezione	Tipo Cavo			Codice	Tipo Presa	Omologazione	Prot. Termica	Peso	Dimensioni (cm)	Pallet
											
3G - 230V	1,5 mm ²	35 m	H05VV-F	800 W	2000 W	882400	NO		11,3 Kg	50 x 43,5 x 23,5	28 pz
						882450	SCHUKO		11,4 Kg	50 x 43,5 x 23,5	28 pz
			H07RN-F			882500	NO		11,2 Kg	50 x 43,5 x 23,5	28 pz
5G - 400V	1,5 mm ²	30 m	H05VV-F	1000 W	3000 W	882600	NO		12,2 Kg	50 x 43,5 x 23,5	28 pz
						882650	EUROPE		12,6 Kg	50 x 43,5 x 23,5	28 pz
						882700	NO		13,4 Kg	50 x 43,5 x 23,5	28 pz
			H07RN-F			882750	EUROPE		13,8 Kg	50 x 43,5 x 23,5	28 pz
		2,5 mm ²	25 m	H07RN-F	2800 W	5000 W	882800	NO		14,7 Kg	50 x 43,5 x 23,5
						882850	EUROPE		15,2 Kg	50 x 43,5 x 23,5	28 pz



Roll Extra

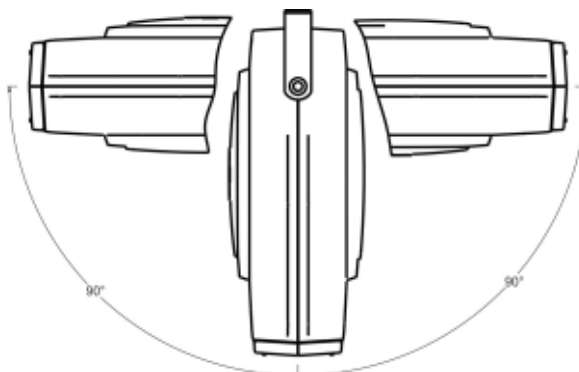
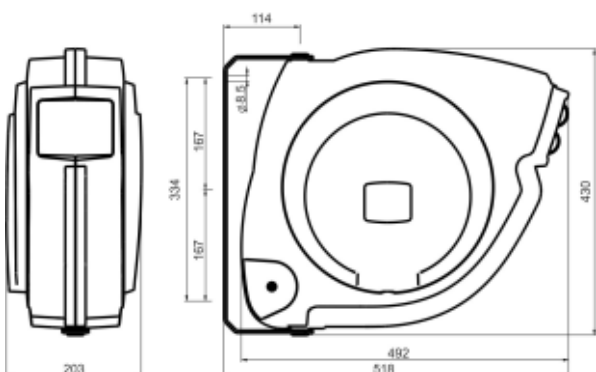

- Rullini guidacavo
- Cable guide rollers
- Kabel-Fuehrungsrollen
- Galets guide câble

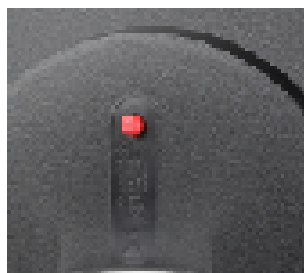

- Disgiuntore ripristinabile
- Circuit-braker manually restorable
- Thermostat
- Dijoncteur à reprise



- Sistema di bloccaggio del cavo a lunghezza desiderata
- Cable ratched stop device easily removable
- Sonder-Kabel Arretierungsvorrichtung
- Système de blocage du câble à longueur désirée